













جعبه ابزارهای کارگاهی Roller Chests

رال رنگ‌ها:



 Code: 72021 Page 2	 Code: 727 Page 7	 Code: 501403 Page 14
 Code: 72034 Page 3	 Code: 728 Page 8	 Code: 501400 Page 14
 Code: 72025 Page 3	 Code: 7285 Page 9	 Code: 501700 Page 15
 Code: 72015 Page 3	 Code: 728N Page 10	 Code: 501700 Page 15
 Code: 72033 Page 4	 Code: 910 Page 11	 Code: 725M Page 16
 Code: 72032 Page 5	 Code: 911 Page 11	 Code: 988M Page 17
 Code: 72030 Page 5	 Code: 994 Page 12	 Code: 455M Page 17
 Code: 72031 Page 5	 Code: 720L32 Page 13	 Code: 497G Page 18
 Code: 725 Page 6	 Code: 720L31 Page 13	 Code: 736 Page 18

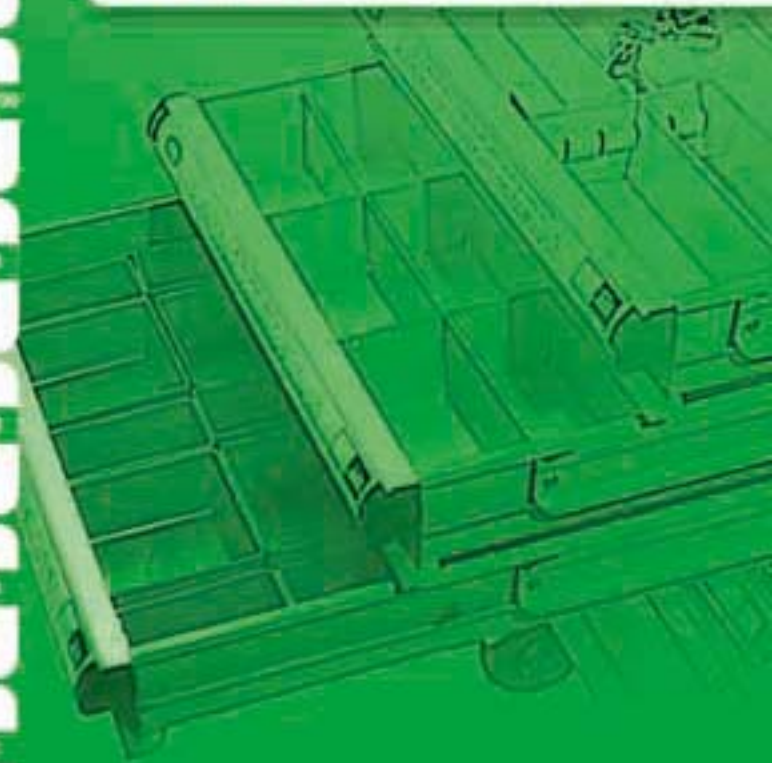

حق هرگونه تغییرات، اصلاحات و بهینه سازی
محصولات شایع ابزار برای این واحد صنعتی محفوظ است



Code: 726B1

Drawers Dimension

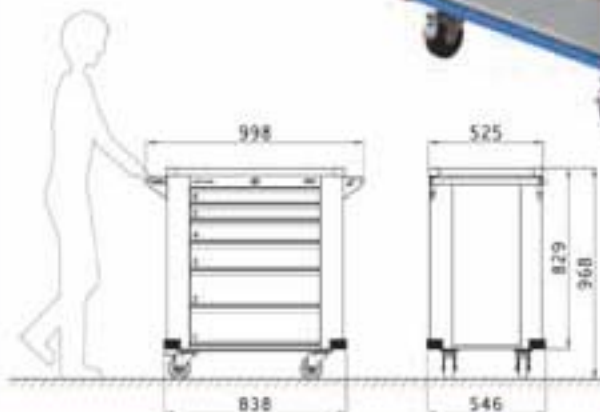
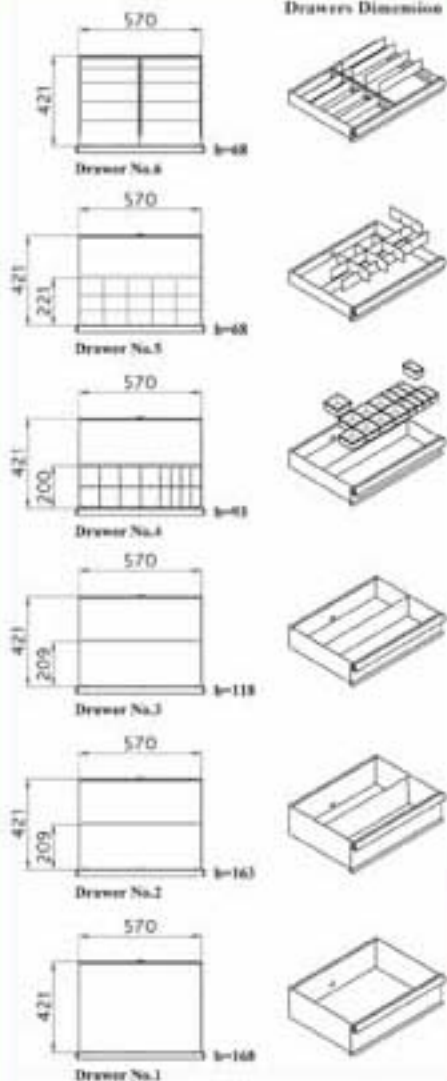







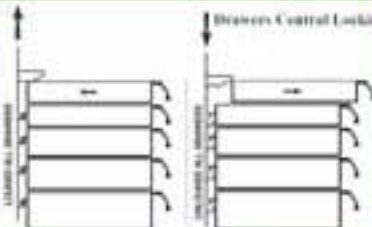



Drawers Loading Max = 60kg



Drawers Control Locking



 5010070410000	Full Package <input checked="" type="checkbox"/>
 5010070220000	Half Package <input type="checkbox"/>
 5010070250000	Size : 830x560x970mm
	74 kg

	Glide Rail <input checked="" type="checkbox"/>		- Stop & NonStop Wheels - To Resist Gasoline, Oil & Solvents Corrosions		- With Central Lock System for Drawers		- Plastic Guards for Coating Safety Preservation		Upper Surface		Electrostatic Sys. Home Made Custom Made
	Ballbearing Rail <input type="checkbox"/>								Lower Surface		- Top Cover
	Ball Rail <input type="checkbox"/>										

Roller Chests / چرخه های ابزارآلات



Code: 726B4

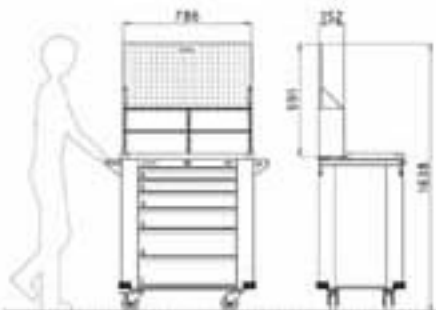

	Clips		5010076110000
<input type="checkbox"/>	Full Package		5010076210000
<input checked="" type="checkbox"/>	Half Package		5010076310000
Size : 830x560x1675mm		Pages 61-69	
	88 kg	009001	009002 009142 009030 009117

Code: 726B5

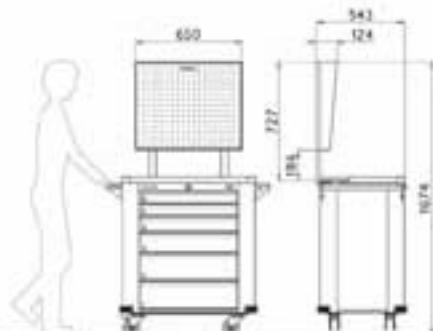

With The MDF Surface			
	Clips		5010076410000
<input type="checkbox"/>	Full Package		5010076210000
<input checked="" type="checkbox"/>	Half Package		5010076310000
Size : 830x560x1680mm		Pages 61-69 009042 009043	
	78 kg	009001	009002 009142 009030 009117

Code: 726B15

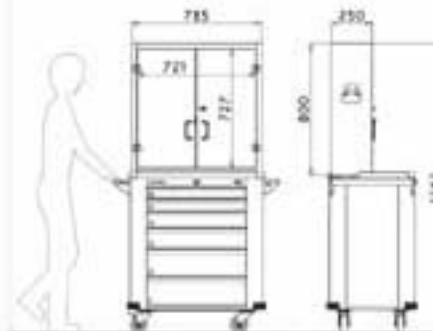

	Clips		5010076410000
	Side Handle		5010076210000
	Lifter Handle		5010076310000
Pages 61-69			
<input checked="" type="checkbox"/>	Full Package	009001	009002 009003 009142 009117
<input type="checkbox"/>	Half Package	009043	009034 009106 009115 009125
Size : 830x560x1750mm		009128 009042 009205 009130	
	91 kg		



Code: 726B3

Drawers Dimension

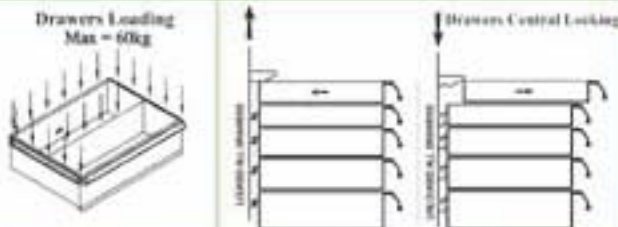
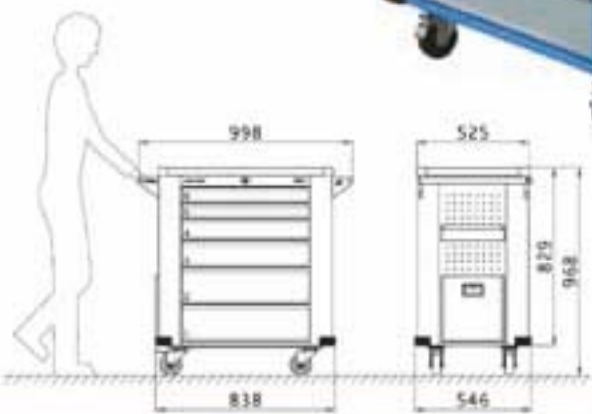
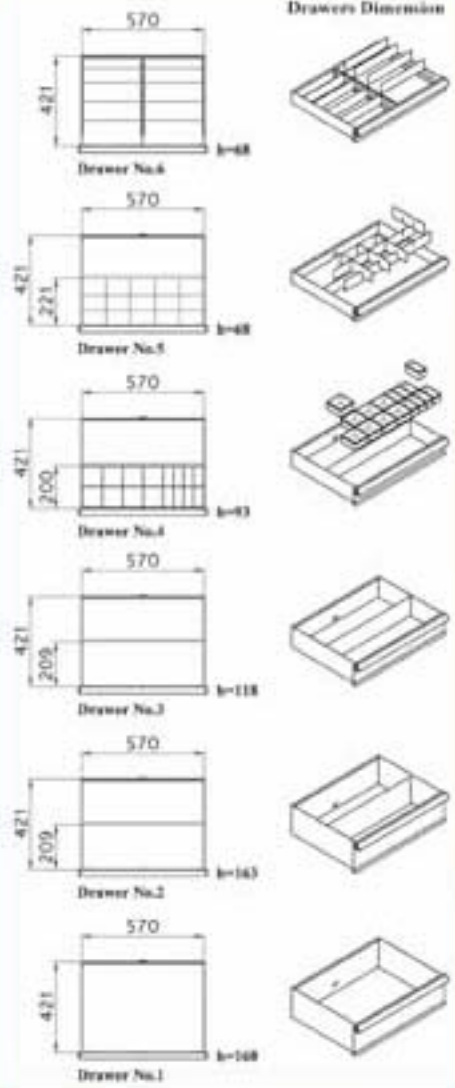

	5010070410000
	5010070220000
	5010070230000
	Pages 61-69 009205 009002 009003 009212
<input checked="" type="checkbox"/> Full Package	Size : 830x500x970mm
<input type="checkbox"/> Half Package	81 kg

	Glide Rail <input checked="" type="checkbox"/>		Ballbearing Rail <input type="checkbox"/>		Ball Rail <input type="checkbox"/>		- Stop & NonStop Wheels - To Resist Gasoline, Oil & Solvents Corrosions		- With Central Lock System for Drawers		- Plastic Guards for Coating Safety Preservation		Upper Surface		Lower Surface		Electrostatic Sys. Routine Made Custom Made
	- Top Cover		Clips														

Roller Chests / کابینة ابزار روی چرخ



Code: 726B2

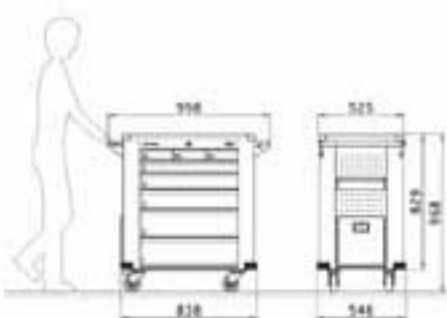

Code: 7298

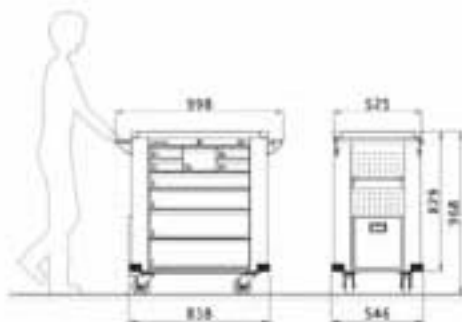

Code: 726X

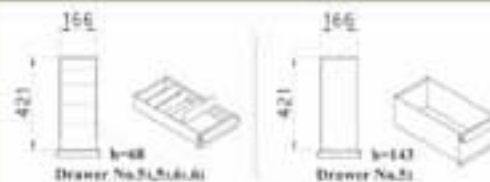
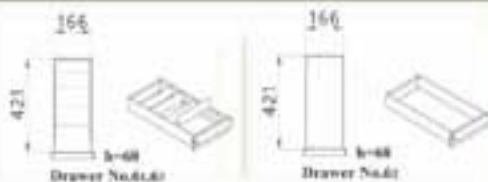
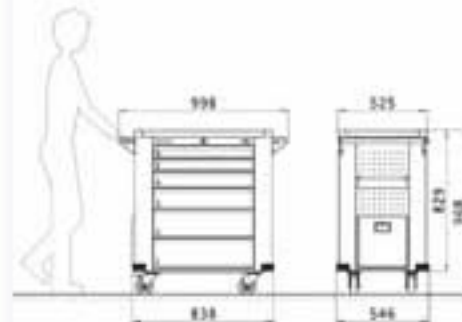

Pages 61-69

Full Package Half Package



Full Package Half Package



Full Package Half Package



Size : 830x560x970mm

Size : 830x560x970mm

Size : 830x560x970mm

85 kg

87 kg

78 kg

Ball Rail



Drawers Dimension

Code: 727

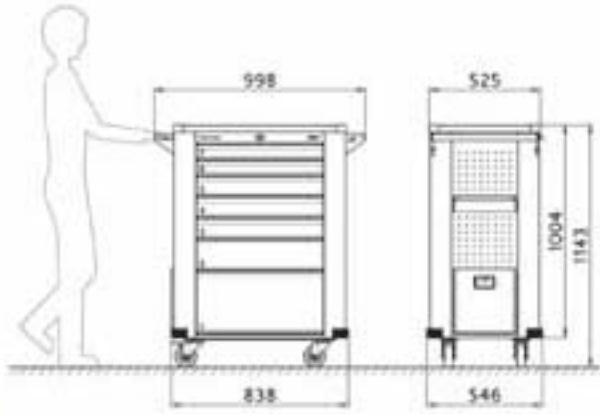
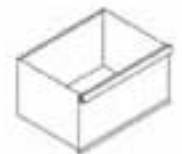
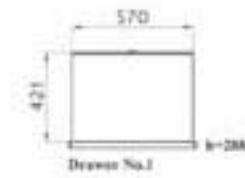
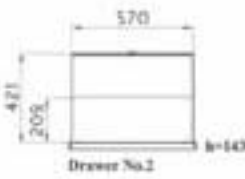
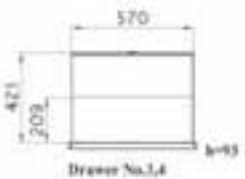
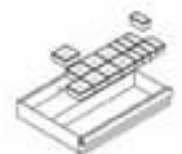
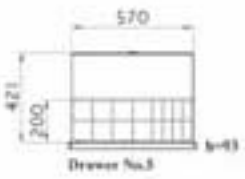
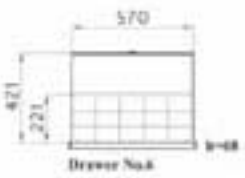
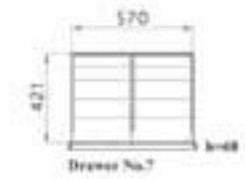

	5813070410000
	5813070220000
	5813070230000
	Pages 61-69 009205 009602 009603 009212
Full Package <input checked="" type="checkbox"/>	Size : 850x560x1150mm
Half Package <input type="checkbox"/>	84 kg

تجهیز ابزارهای کارگاهی / Roller Chests



Code: 728

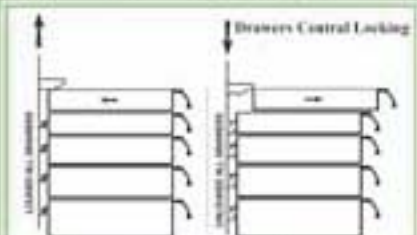
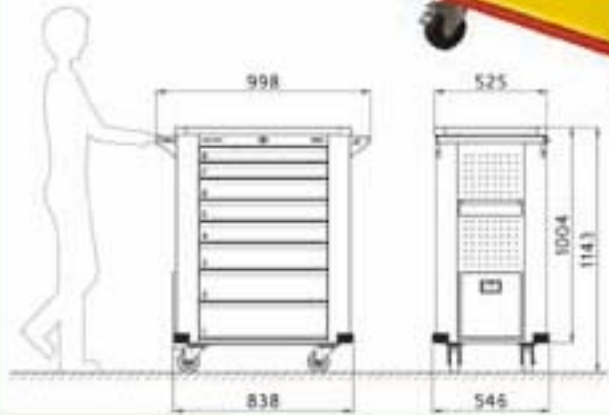
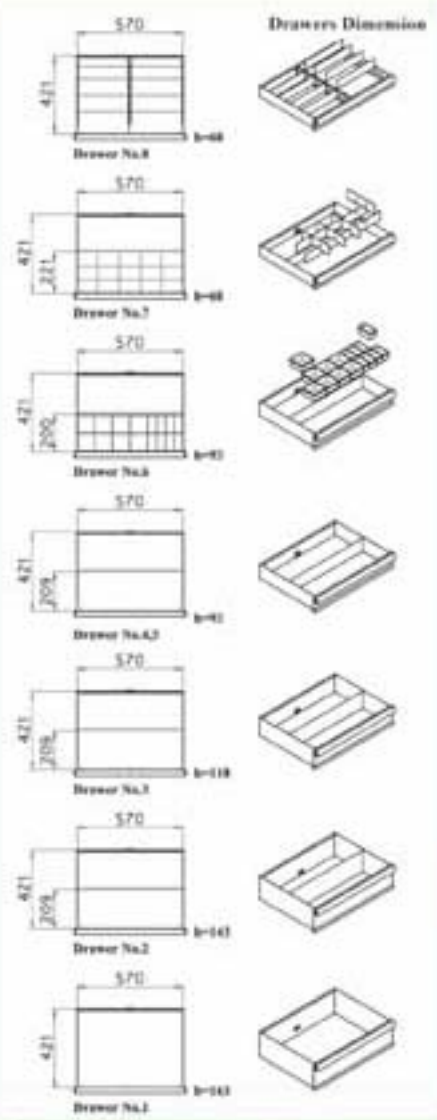

	9010070410000
	9010070220000
	9010070230000
	909205 909002 909003 909212
<input checked="" type="checkbox"/> Full Package	Size : 830x500x1150mm
<input type="checkbox"/> Half Package	99 kg

	Glide Rail <input checked="" type="checkbox"/>
	Ballbearing Rail <input type="checkbox"/>
	Ball Rail <input type="checkbox"/>

	Stop & NonStop Wheels
	To Resist Gasoline, Oil & Solvents Corrosions

	With Central Lock System for Drawers
--	--------------------------------------

	Plastic Guards for Coating Safety Preservation
	Upper Surface
	Lower Surface

	Electrostatic Sys. Home Made
	Electrostatic Sys. Custom Made
	Top Cover
	Clips

Roller Chests / کابینت های رولری



Code: 7285 >>>

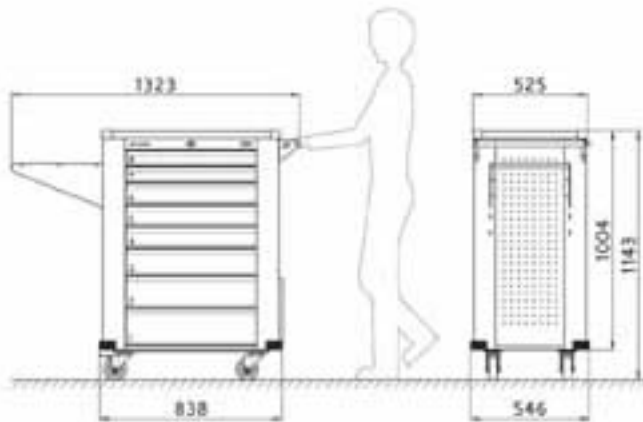

تجهیز ابزارهای کارگاهی / Roller Chests

	Glide Rail <input type="checkbox"/>	 Drawers Loading Max = 40kg		9010070410000
	Ballbearing Rail <input type="checkbox"/>			9010070220000
	Ballbearing Rail <input type="checkbox"/>			9010070250000
	Ball Rail <input checked="" type="checkbox"/>		Pages 61-69	009205 009001 009212
			Full Package <input checked="" type="checkbox"/>	Size : 830x570x1150mm
			Half Package <input type="checkbox"/>	90 kg



Code: 728N

Drawers Dimension

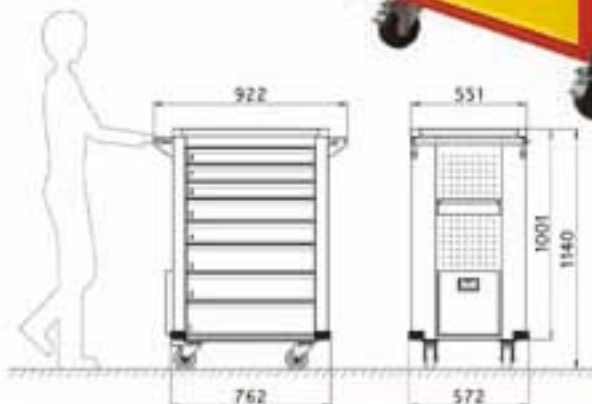
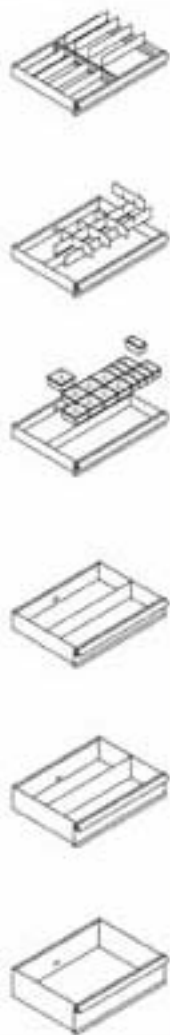
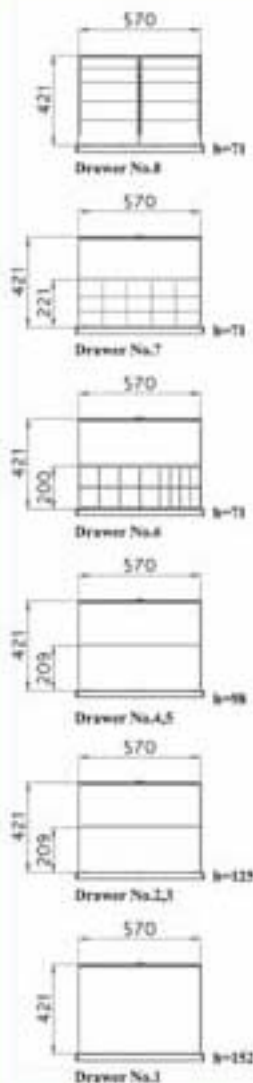

Drawers Loading
Max = 60kg

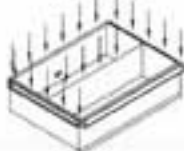

Drawers Control Locking

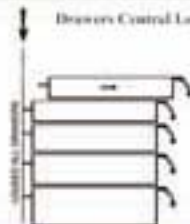

Clips



Pages 61-69 009205 009002 009003 009212

Full Package
Half Package

Size : 760x600x1140mm
99 kg

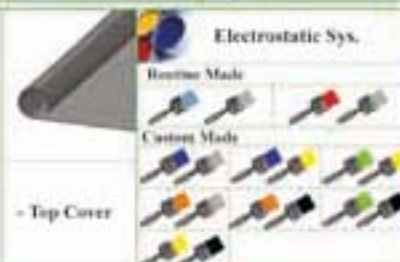
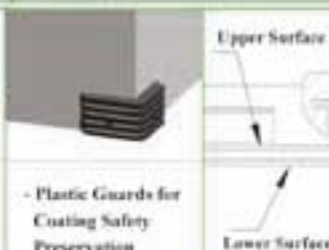



Code: 510

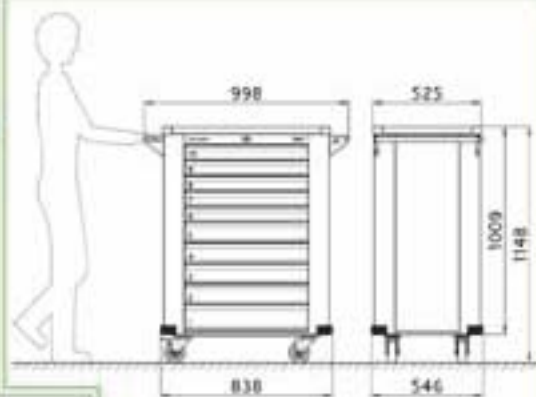

Drawers Dimension

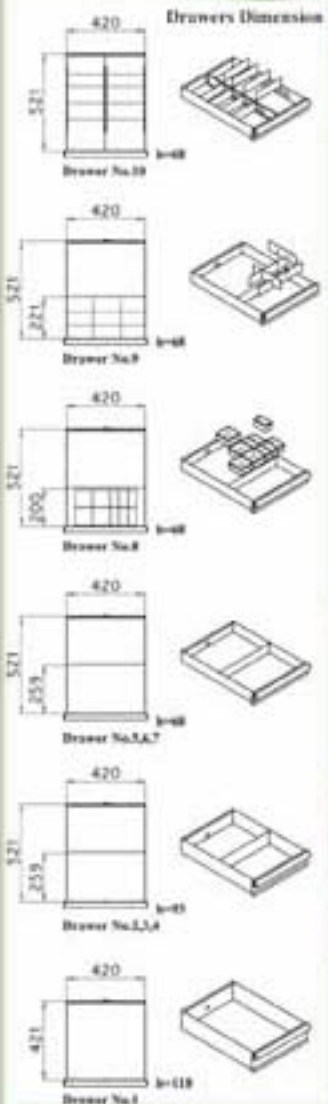
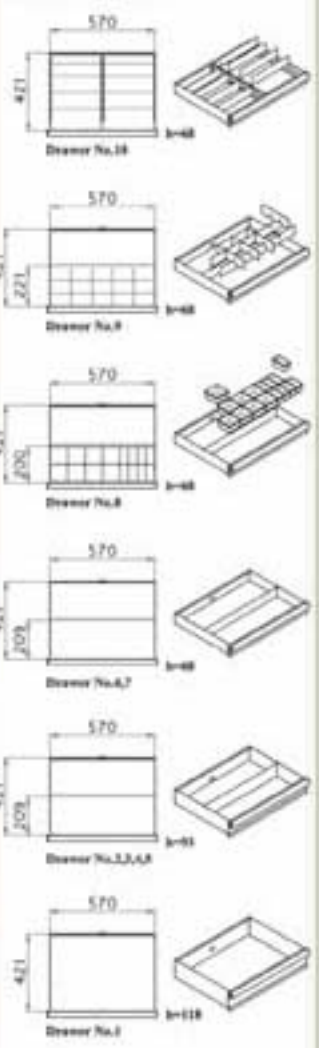

Drawers Loading Max = 60kg



Drawers Loading Max = 40kg



- 9010070410000
- 9010070220000
- 9010070230000
- Full Package Size : 870x590x110mm
- Half Package 97 kg

Code: 511

- 9010070410000
- 9010070220000
- 9010070230000
- Full Package Size : 700x600x1135mm
- Half Package 82 kg

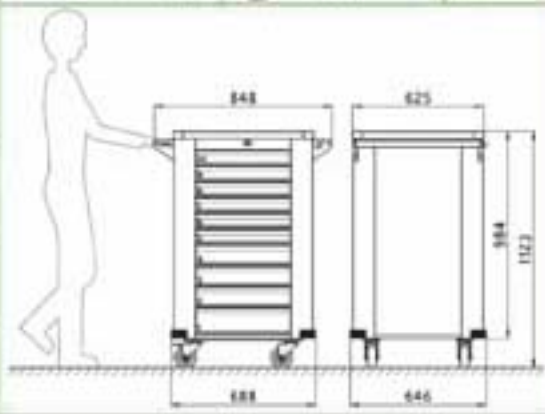

- Glide Rail
- Ballbearing Rail
- Ball Rail

- Glide Rail
- Ballbearing Rail
- Ball Rail



Code: 594

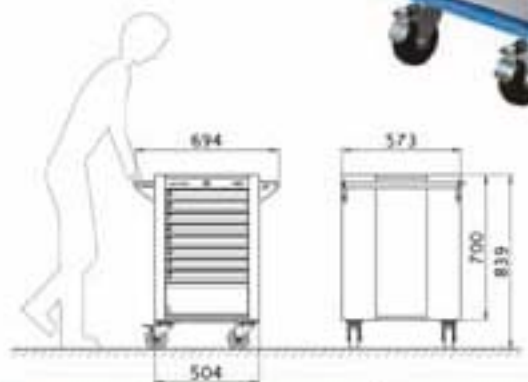

Drawers Dimension

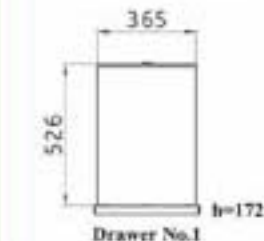
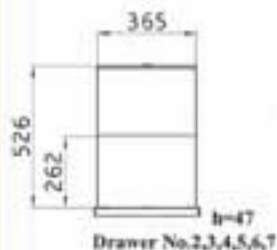
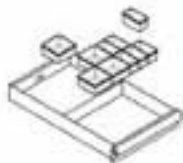
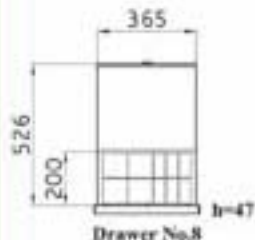
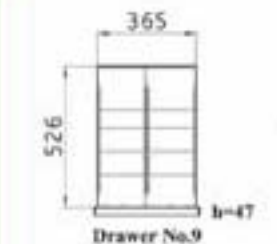

	Glide Rail <input checked="" type="checkbox"/>	Drawers Loading Max = 40kg 		5010070410000
	Ballbearing Rail <input type="checkbox"/>			5010070220000
	Ball Rail <input type="checkbox"/>			5010070230000
			Full Package <input checked="" type="checkbox"/> Half Package <input type="checkbox"/>	Size : 575x505x835mm 65 kg

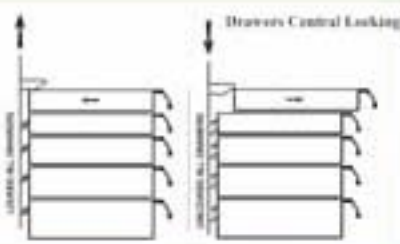

- Stop & NonStop Wheels
- To Resist Gasoline, Oil & Solvents Corrosions
- With Central Lock System for Drawers
- Plastic Guards for Coating Safety Preservation

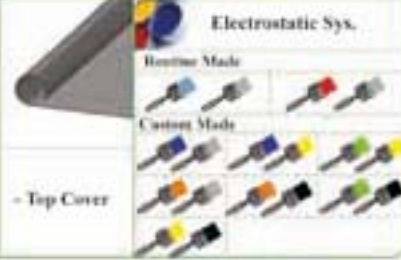

- Top Cover

Roller Chests / کابینت های رولری



Code: 726LX2

Code: 726LX1

Drawers Dimension

Drawers Dimension

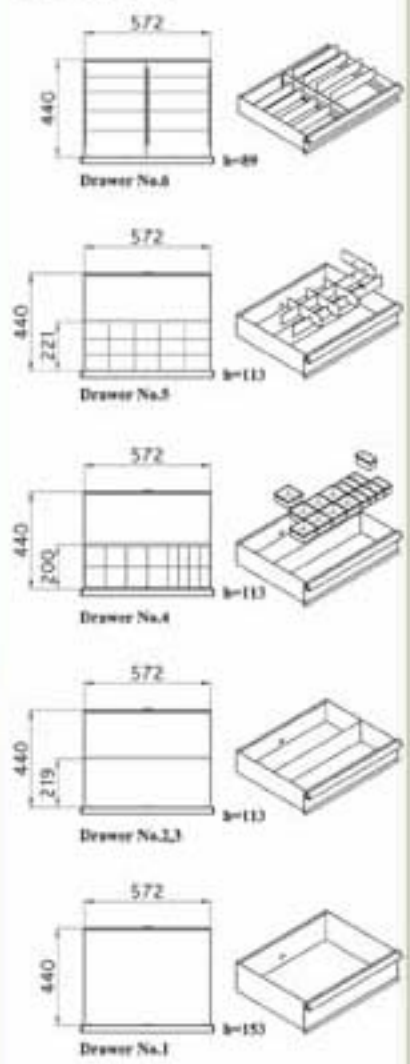
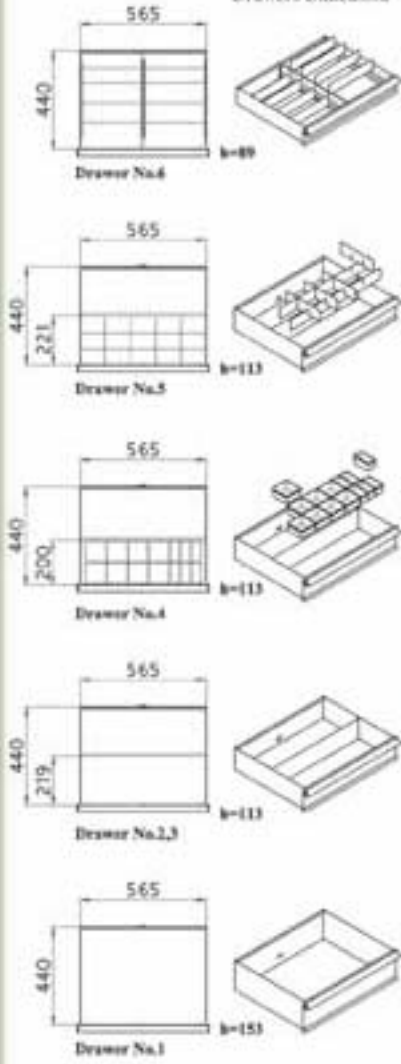

تجهیز ابزارهای کارگاهی / Roller Chests

	5010070410000		5010070220000		5010070230000
	Pages 61-69	009124	009042	009115	009117
	009128	009048	009030	009142	009205
	009001	009215			
	<input checked="" type="checkbox"/> Full Package	<input type="checkbox"/> Half Package	Size : 850x720x980mm		100 kg

Drawers Loading Max = 60kg

Drawers Loading Max = 40kg

	5010070410000		5010070220000		5010070230000
	Pages 61-69	009124	009042	009115	009117
	009128	009048	009030	009142	009205
	009001	009215			
	<input checked="" type="checkbox"/> Full Package	<input type="checkbox"/> Half Package	Size : 850x720x980mm		102 kg



Drawers Dimension

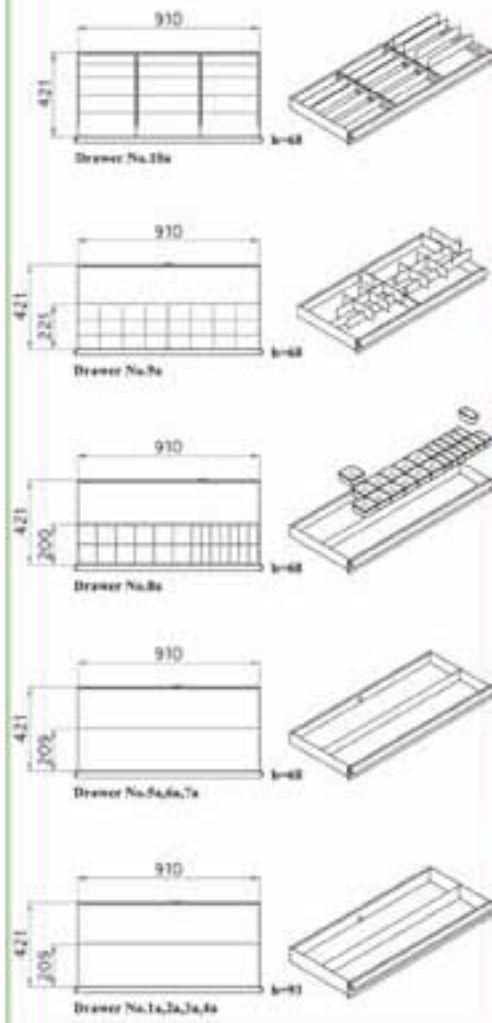

Code: SU 1400X



155 kg

Code: SU 1400

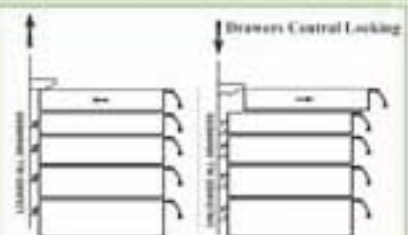
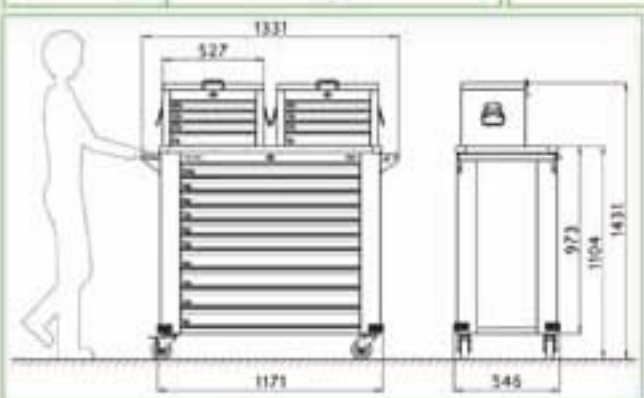

Side Handle	Lamber Handle	5010070410000
5010070220000	5010070230000	
<input checked="" type="checkbox"/> Full Package	<input type="checkbox"/> Separated Packaging	
<input type="checkbox"/> Half Package	185 kg	

	Glide Rail <input type="checkbox"/>
	Ballbearing Rail <input type="checkbox"/>
	Ball Rail <input checked="" type="checkbox"/>

	- Stop & NonStop Wheels
	- To Resist Gasoline, Oil & Solvents Corrosions

	- With Central Lock System for Drawers
--	--

	- Plastic Guards for Coating Safety Preservation
	Upper Surface
	Lower Surface

	Electrostatic Sys. Home Made
	Electrostatic Sys. Custom Made
	- Top Cover

Roller Chests / کابینة ابزار چرخي



made in IRAN

Drawers Dimension

Code: SU1700X

Code: SU1700

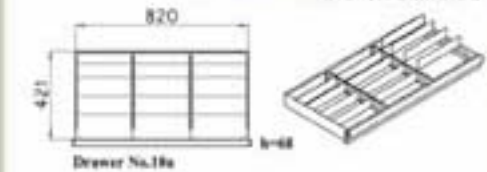

Drawer No.18a

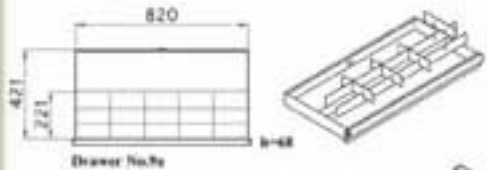

Drawer No.7a

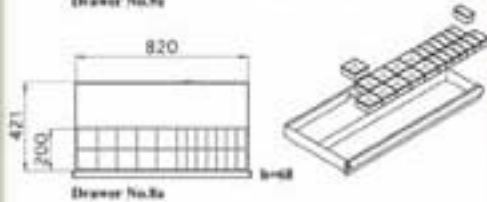

Drawer No.8a

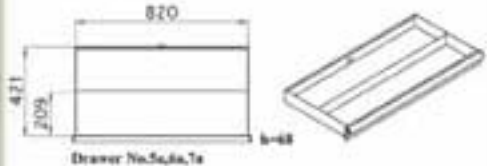

Drawer No.5a,6a,7a

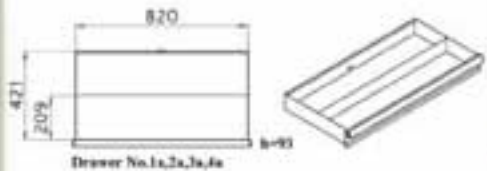

Drawer No.1a,2a,3a,4a

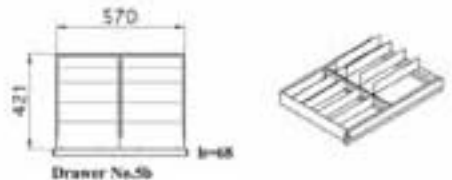

Drawer No.5b

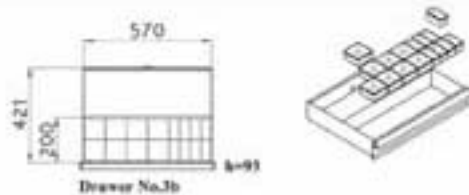

Drawer No.3b

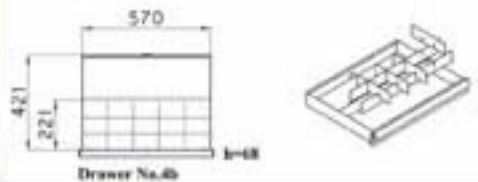

Drawer No.4b

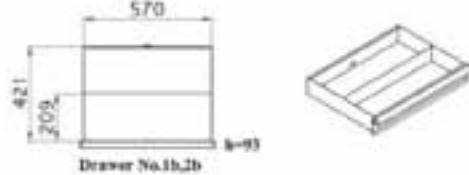

Drawer No.1b,2b



210 kg

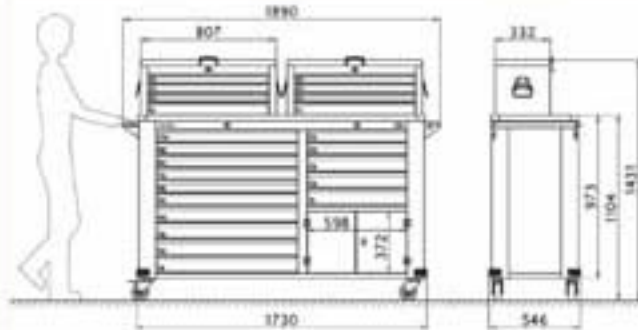

		- Cabinet Lock
	<input checked="" type="checkbox"/> Full Package	<input type="checkbox"/> Separated Packaging
	<input type="checkbox"/> Half Package	
		265 kg



Drawers Dimension

Code: 725M

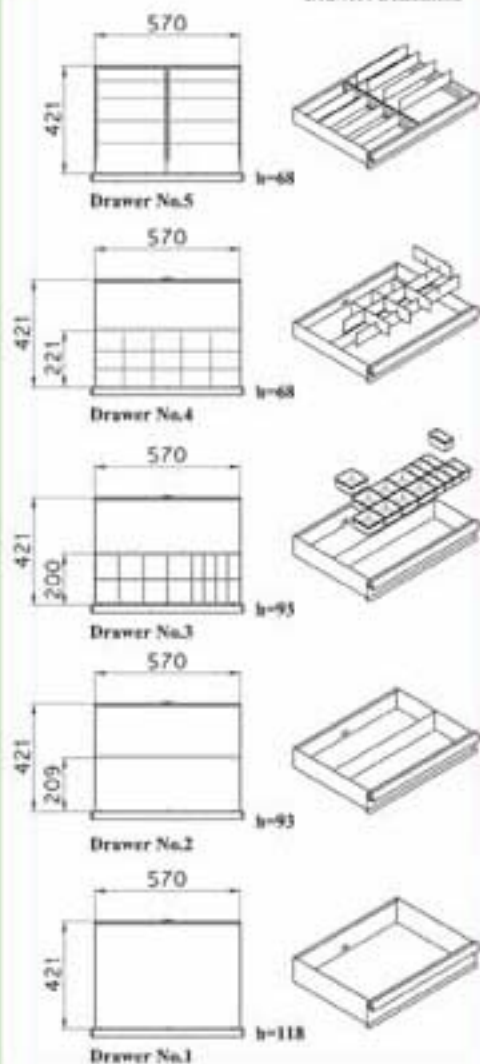

Drawers Loading
Max = 60kg

Full Package
 Half Package

Size : 720x500x785mm

88 kg

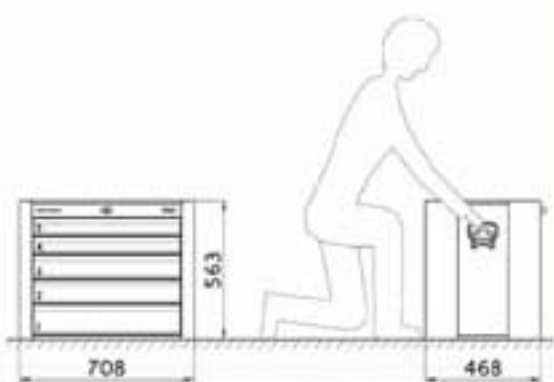

Drawers Control Locking

	Glide Rail <input checked="" type="checkbox"/>				
	Ballbearing Rail <input type="checkbox"/>				
	Ball Rail <input type="checkbox"/>				

Routine Made
 Custom Made

Roller Chests / جعبه ابزار رولری / کابین



Code: 584M

Code: 455M

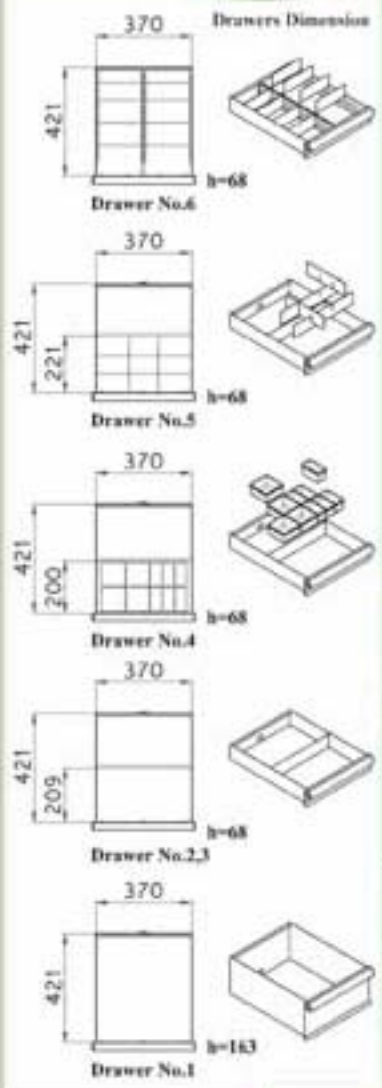

Full Package 
 Half Package 

Size : 515x500x785mm

45 kg

Unlock
Lock

- Stop & NonStop Wheels
- To Resist Gasoline, Oil & Solvents Corrosion

Full Package 
 Half Package 

Size : 580x490x500mm

32.7 kg

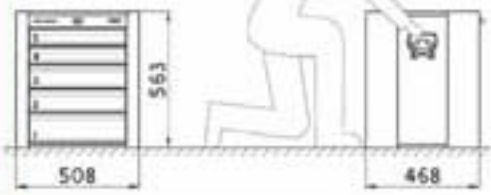
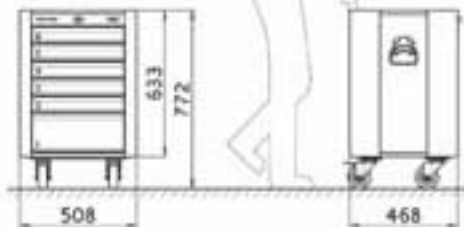
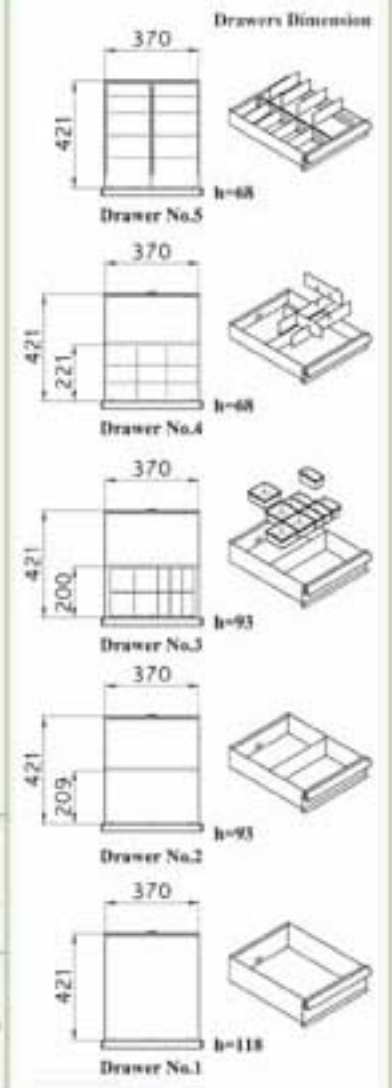

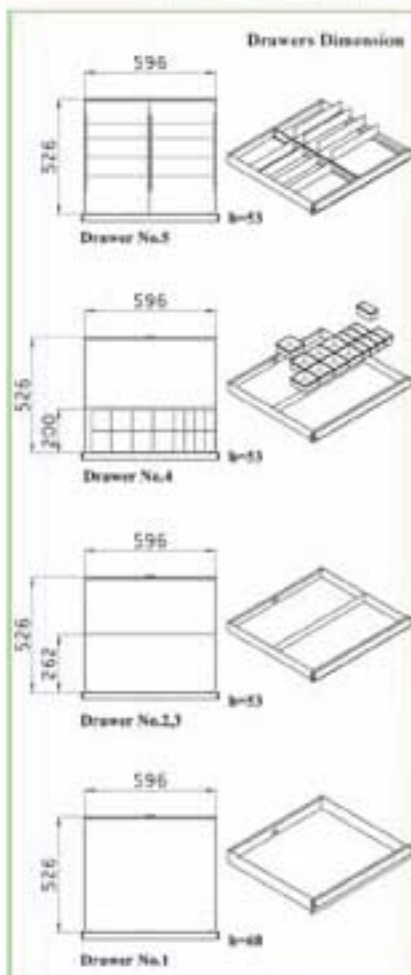

Full Package

Half Package

Size : 720x500x785mm

65 kg

Stop & NonStop Wheels
- To Resist Gasoline, Oil & Solvents Corrosions

Carrier
Lock
Unlock

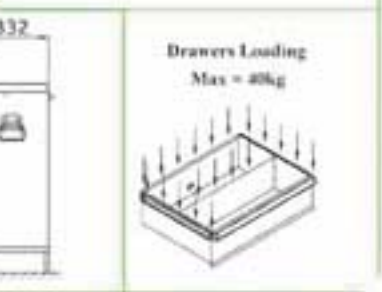
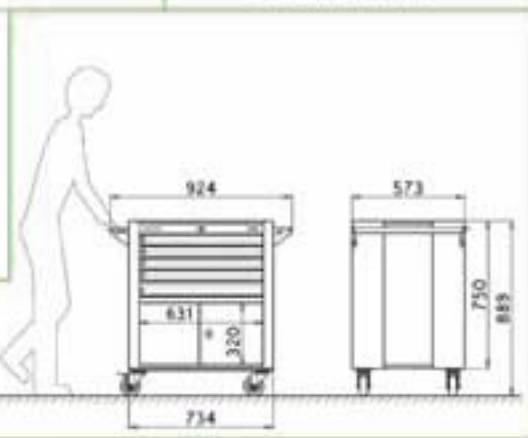
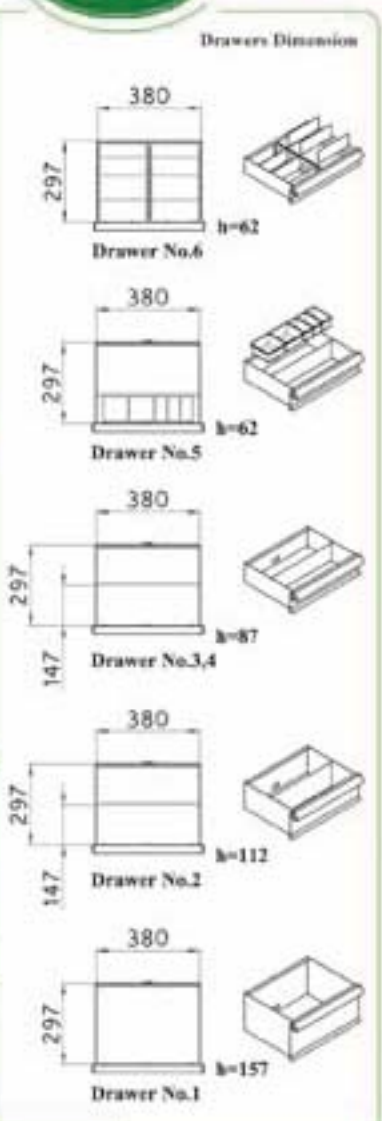

Roller Chests / کابین های چرخدار